



Pax Norte black

Fully automatic bathroom fan with possibility of app control. With built-in multi-pole switch

- Moisture and light sensors
- Possibility of app control
- Integrated 12 volt input
- Heat distributor
- Matt black design

Specifikation

Article codes

Art no:	1561-1
EAN 13:	7391477156110
ETIM:	EC001141

Measurement

Channel dimension Ø :	100 mm
Product Width:	177 mm
Product Height:	177 mm
Product Depth:	81 mm
Product Weight:	0.48 kg
Product Circular Measure Ø:	177 mm

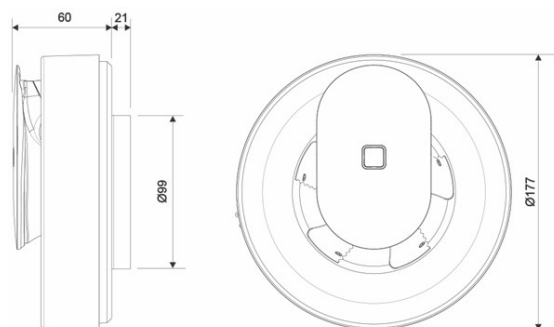

Characteristics

Functions:	Run on timer, Intelligent humidstat, Constant flow, Light sensor, Temperature sensor, Timer, Switch live
Installation Type, Wall, Ceiling Etc:	Horizontal, Vertical
Maximum Pressure:	25 Pa
Free To Air Max (m3/h):	110 m ³ /h
Max Watt(W):	4 W
Supply Voltage (12V-400V):	100V AC, 110V AC, 12V DC, 230V AC
Electrical Supply Phase:	1-Phase
Insulation Class:	II (shall not be protectively grounded)
Type Of Motor:	EC
Wireless Control Option:	Bluetooth LE
Protection (Ip):	IP 44
Finish:	Matte
Colour:	Black
Material:	Plastic
Plastic Material Detail:	ABS
Maximum Operating Temperature:	50 °C
Minimum Operating Temperature:	0 °C
Warranty Number Of Years:	5 years

Description/Function

Pax Norte is a fully automatic bathroom fan, ready to use in its default. The fan's basic setting is for continuous operation at low speed with humidistat and light sensors activated with three speed modes.

Pax Norte works continuously with a basic flow of approximately 30 m³/h.

When a light is switched on or when shadows change when someone moves in the room, the flow increases to approximately 60 m³/h.

If the humidity rises rapidly, for example when the shower is on, the fan goes up to maximum flow at approximately 95 m³/h.

When the humidity has been removed, the fan reverts to the basic flow of approximately 30 m³/h.

This ensures constant healthy air circulation and a better indoor climate throughout the house.

Pax Norte is extremely quiet and, of course, it's approved for use in wet rooms.

The app allows you to select several functions and make adjustments

If you want more functions and adjustments you can download Pax's intelligent app "Pax Wireless". With the app you can use a smart calendar function, boost mode, airing function and you can program your fan to be a heat transfer.

Via the app you can also pair your fan with your towel warmer with Momento II timer. Then the towel warmer switches on automatically when the fan's humidity sensor detects an increased humidity level, for example when you start showering.

Innovation in every detail

Pax Norte was developed and is manufactured in Sweden. As usual, we've taken an uncompromising approach to materials, the environment and quality. Norte is full of state-of-the-art control technology and its performance is more than 20% better than previous models. Pax Norte also offers minimum energy consumption and is very easy to clean.

A fan with unexpected possibilities









Pax Norte was developed for several markets other than just the household market. The integrated 12 volt input makes it possible to use the fan in boats and motorhomes, for example. Pax Norte may be one of the most versatile fans we have ever produced.

And, as with all Pax products, every single fan has undergone thorough quality and safety tests. This is why we provide a 5-year warranty on your Pax Norte.

What you get with a Pax Norte:

- Fully automatic bathroom fan, ready to use in its default
- Possibility to select several functions and make adjustments via the app Pax Wireless
- Easy to install and use
- Very quiet 17-20dB (A) 3m
- Effective, 110 m³ / h free blowing
- Energy-saving, maximum 4 W
- Boost function
- Separate 12 V input
- Safe and secure. Each fan is thoroughly tested
- Developed and manufactured in Sweden

Accessories

	Product	Stock code
	Wall pipe Ø100 1-pack	5913-1
	Backdraught shutter Ø98x74	8127-1
	Cover plate Passad/Norte black	8143-8
	External wall grille Ø100 white	8156-1
	External wall grille Ø100 black	8156-2
	External wall grille Ø100 red	8156-3
	Wall pipe Ø100 2-pack	8157-1
	Windbreaker hood	8158-1
	Windbreaker hood stainless	8158-4