



Pax Passad 30

A fan with moisture control and light sensor. Perfect for the bathroom in homes with natural features or in houses where the mechanical exhaust air system needs completion.

- Humidity sensor
- Timer function via presence sensor
- Manually via switch, with or without timer function
- Replaces Pax 230

Specifikation

Article codes

Art no:	1855-1
EAN 13:	7391477185516
ETIM:	EC001141

Measurement

Channel dimension Ø :	100 mm
Product Width:	172 mm
Product Height:	210 mm
Product Depth:	142 mm
Product Weight:	0.6 kg

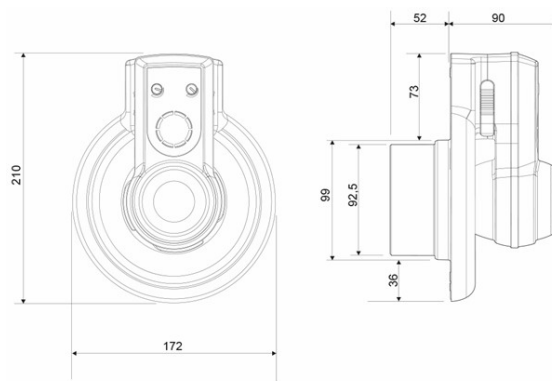

Characteristics

Functions:	Humidistat, Light sensor, Timer, Switch live
Installation Type, Wall, Ceiling Etc:	Horizontal, Vertical
Maximum Pressure:	25 Pa
Free To Air Max (m3/h):	95 m ³ /h
Max Watt(W):	5 W
Supply Voltage (12V-400V):	230V AC
Electrical Supply Phase:	1-Phase
Insulation Class:	II (shall not be protectively grounded)
Type Of Motor:	AC
Protection (Ip):	IP 44
Finish:	Matte
Colour:	White
Material:	Plastic
Plastic Material Detail:	PP
Maximum Operating Temperature:	35 °C
Minimum Operating Temperature:	5 °C
Environmental Certificate:	SundaHus
Warranty Number Of Years:	5 years

Description/Function

Pax Passad 30 is perfect for the bathroom in homes with natural ventilation (ceiling), or in houses where the mechanical exhaust system needs supplementation (but via own duct). The fan starts via adjustable presence sensor, or when the moisture level exceeds the set value.

Experience and smart technology

We have developed the Pax Passad series so you can easily find a model that ensures ventilation in your home.

Carefree use

A Pax Passad fan is primarily intended to amplify the exhaust air flow in homes with natural ventilation. They are very simple both to install and use. Enough space in the frame part helps the installer's job and cleaning is done with one simple operation, without any need for tools.

The fans' smart functions give you care free ventilation and automatically help your house to "breathe" when it is needed most. The result is an indoor environment that makes both you and the house feel good!

Models

The distinguishing features for all fans in the Pax Passad series are that they are extremely quiet, highly efficient, made from environmentally friendly material and have negligible energy consumption. The fans are obviously approved for installation in wet areas.









Secure - Safe - Environmentally friendly

The Pax Passad series is manufactured in materials selected with a very low environmental impact. The fans are obviously recyclable. Pax Passad is an environmentally recommended product by Sunda Hus, among others. For your safety, every single Pax fan undergoes very thorough quality and safety tests. To emphasize the quality awareness, we offer a five year warranty for Pax Passad.

Pax Passad

1. dB(A) 3 m value 27,9
2. Efficient, 95 m³ / h free blowing
3. Easy to install and use
4. Energy efficient, max 5 W
5. Environmentally friendly, completely recyclable
6. Safe - every single fan is quality and safety tested
7. Developed and manufactured in Sweden
8. 5-year warranty.

Accessories

	Product	Stock code
	Wall pipe Ø100 1-pack	5913-1
	All-pole cut-out Passad	8104-3
	Gravity shutter #140, white	8124
	Backdraught shutter Passad	8125-1
	Cover plate Passad/Norte white	8143-6
	Spacer frame Passad	8145-1
	External wall grille Ø100 white	8156-1
	External wall grille Ø100 black	8156-2
	External wall grille Ø100 red	8156-3
	Wall pipe Ø100 2-pack	8157-1